

PRODUCT DATA SHEET



PRODUCT CODE

CAQSVC10X8B

RANGE

Clear 6

DESCRIPTION

Clear 6 Quadrant Single Door 1000 x 800 Box B Brushed Nickel

CATEGORY	Showering
WARRANTY DETAILS	Lifetime
COLOUR	Brushed Nickel
FINISH APPLICATION	Anodised
PRIMARY MATERIAL	Glass
SECONDARY MATERIAL	Aluminum
INSTALL TYPE	Wall Mounted
PRODUCT WIDTH MM	960
PRODUCT HEIGHT MM	1950
PRODUCT DEPTH MM	760
PRODUCT NET WEIGHT KG	26

STANDARDS	EN14428
HANDING SHOWERING	Universal
GLASS THICKNESS	6mm
EASY CLEAN	Yes
MAGNETIC DOOR STRIPS	No
POWER SHOWER PROOF	Yes
NUMBER OF DOORS	0
SAFETY GLASS	Yes
REMOVABLE SEALS	Yes
QUICK RELEASE ROLLERS	No
WET ROOM COMPATIBLE	Yes
DOOR A INFORMATION	Quadrant single door
DOOR OPENING	436

TECHNICAL DIMENSIONS

Dimensions in mm unless otherwise specified.

Tolerances (per material type) apply.

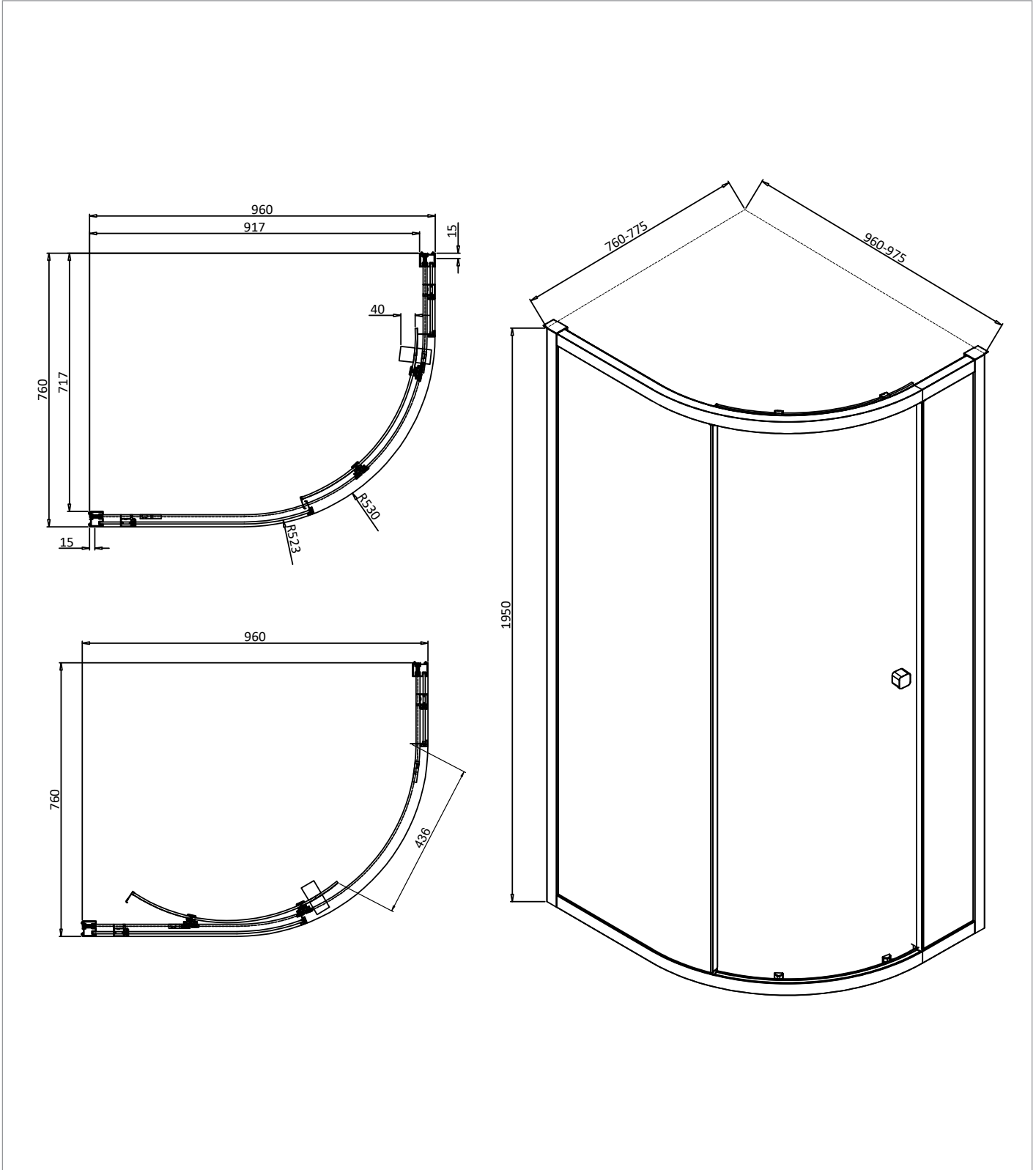

SPARES LIST

Only the parts labelled are available as spares.

NUMBER	PART CODE	DESCRIPTION
1	CA600048	Clear 6 Quadrant single 800 seal pack
2	CA600049	Clear 6 Quadrant single 900-1200 seal pack