

PRODUCT DATA SHEET



PRODUCT CODE

WCF98X45R

RANGE

Toilet Cisterns

DESCRIPTION

WC Support Frame 0.98M Height (with dual flush concealed cistern & installation kit)

WEBSITE LINK

[Click Here](#)

CATEGORY	Sanitaryware
WARRANTY DETAILS	5 Years
PRIMARY MATERIAL	Steel
SECONDARY MATERIAL	Plastic
INSTALL TYPE	Floor Standing
PRODUCT WIDTH MM	450
PRODUCT HEIGHT MM	980
PRODUCT LENGTH MM	159
PRODUCT NET WEIGHT KG	12.58

STANDARDS	BS EN 14055:2018
APPROVAL	WRAS - 2303396
FIXINGS INCLUDED	Yes
FLUSH VOLUME	6/4L
FIXING TYPE	Floor fixing
CISTERN FLUSH MECHANISM	Dual Flush with Mechanical Flush Plate
NOISE CLASS	Group I

TECHNICAL DIMENSIONS

Dimensions in mm unless otherwise specified.

Tolerances (per material type) apply.

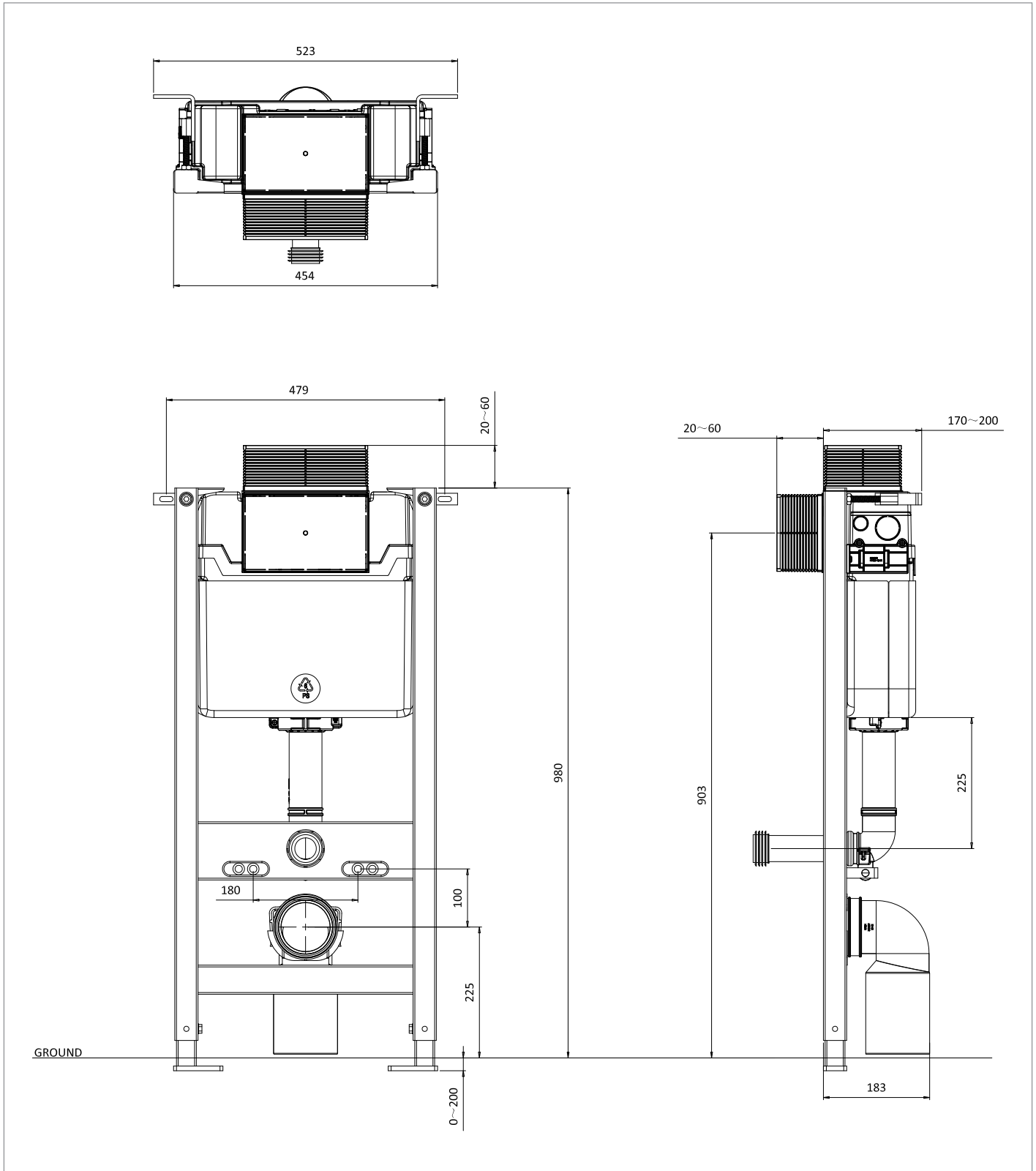

SPARES LIST

Only the parts labelled are available as spares.

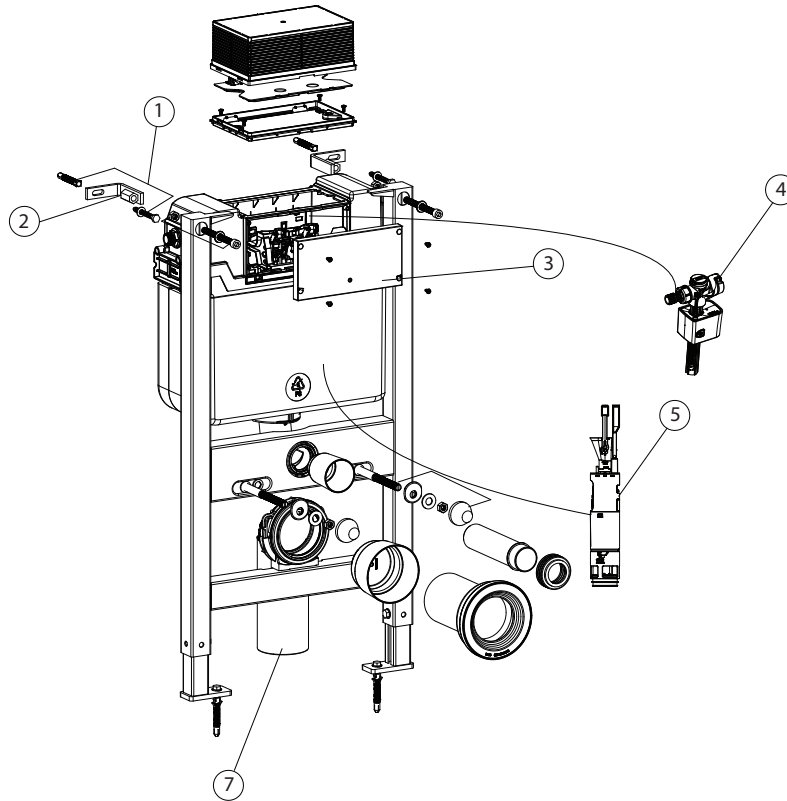

NUMBER	PART CODE	DESCRIPTION
1	CWSP001	Replacement fixing bracket for WCF80X45R/WCF98X45R/WCF114X51R
2	CWSP004	Replacement expansion bolt for concealed frames
3	CWSP008	Flush plate mounting assembly for WCC46X39R/WCF80X45R/WCF98X45R
4	CWSP020	Replacement fill valve for WCC46X39R/WCF80X45R/WCF98X45R
5	CWSP024	Replacement flush valve for WCC46X39R/WCF80X45R/WCF98X45R
6	CWSP027	Replacement flush rod for concealed cisterns and frames
7	CWSP028	Replacement waste pipe for concealed frames