

SCALE 1:2

SECTION A-A

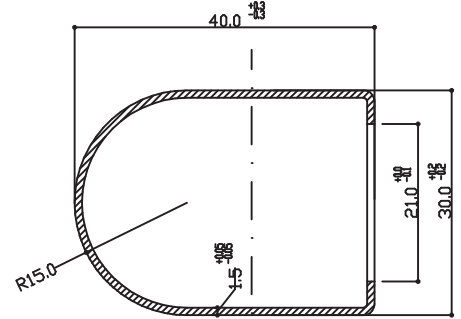

SECTION C-C

SCALE 1:1

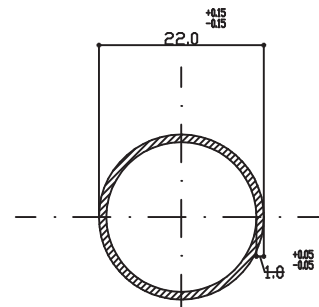

SECTION B-B

SCALE 1:1

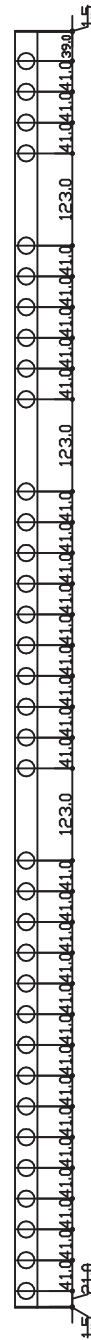
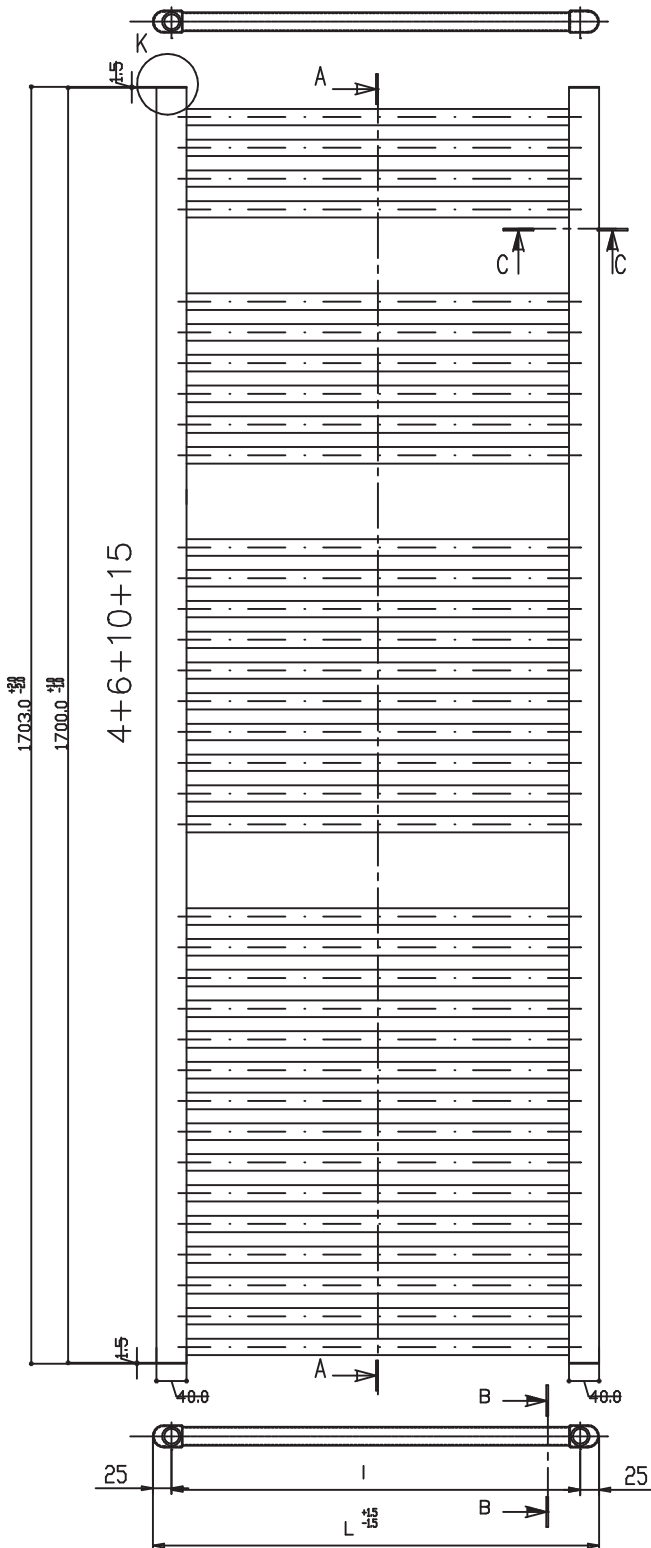

| WIDTH 'L' | PIPE CENTRE 'I' |
|-----------|-----------------|
| 600       | 550             |

**bauhaus**

DESIGN

DE60X170C

Towel warmer 600w x 1700h straight chrome